

Optimizing the Prediction Model of Stock Price in Pharmaceutical Companies Using Multiple Objective Particle Swarm Optimization Algorithm (MOPSO)

Ali Khazaei^a, Babak Hajikarimi^{a,*}, Mohammad Mahdi Mozafari^b

^a Department of Management Science, Abhar branch, Islamic Azad University, Abhar, Iran

^b Faculty of Social Science, Imam Khomeini International University, Qazvin, Iran

Received 15 December 2019 ; Revised 17 September 2020 ; Accepted 15 November 2020

Abstract

The purpose of the research was to optimize the prediction model of stock price in pharmaceutical companies using meta-heuristic algorithm. In this research, optimizing the stock portfolio has been done in two separate phases. The first phase is related to predicting the stock future price based on the past stock information, in which predicting the stock price was done using an artificial neural network. The neural network used in the research was Multilayer Perceptron (MLP) using the back propagation of error algorithm. After predicting the stock price with a neural network, the predicted price data was used to optimize the stock portfolio in the second phase. In the second phase, a multi-objective genetic algorithm was used to optimize the portfolio so the optimal weights are assigned to the stock and the optimal stock portfolio was developed. Having a regression model, the relevant genetic algorithm was designed using MATLAB software. The results showed that the stock portfolio developed by MOPSO algorithm has a better performance under all four risks criteria except the conditional value-at-risk criterion than the algorithms used in the compared article. In all models except the mean-conditional value-at-risk model, the stock portfolios developed by the MOPSO algorithm used in the research have more and more appropriate efficiency. In addition, the results showed that MOPSO algorithm is of good performance at developing and optimizing the stock portfolio and better than other algorithms. Therefore, it can be said that using meta-heuristic MOPSO algorithm used in the research is effective for optimizing stock portfolio.

Keywords: Predicting the Price; Multiple Objective Particle Swarm Optimization Algorithm (MOPSO); Meta-Heuristic.

1. Introduction

Financial markets have become one of the most popular areas of investment in the recent eras because of their unique characteristics such as no need for macro capital, transparency and low cost of transactions, and the absence of default risk (Chang, 2010). In fact, an important part of any country's economy is formed by investing in the stock exchange. Undoubtedly, most of the capital is exchanged through stock markets all over the world and the national economy is strongly influenced by the performance of the stock market. Therefore, we need to learn mechanism and behavior of these markets using different and useful tools. An investor must have a clear insight about the future of market in order to achieve maximum profitability (Bajelan et al., 2016). Predicting stock prices is one of the attractive and challenging tasks, which has attracted many researchers' interest and involved many scientific disciplines (Zhang et al., 2018). Predicting trends and improving the predictive power is of great value for reducing risk (Basak et al., 2018). However, there are many ways for predicting nowadays, it is not easy to predict stock prices clearly and even predict the direction of prices (Zhang et al., 2018). The predictive power of different models varies in different systems (Basak et al., 2018).

The trend of predicting prices in the stock market has been of interest to researchers for many years due to its complex and dynamic nature. It is also a very debatable task due to the ambiguities and variables affecting the change of market index on a certain day. Stock markets are sensitive to rapid changes so random fluctuations may be occurred in their prices. Due to high disorder and instability nature of stock behavior, investing in this market is going along with high risk. Thus, knowledge is needed to clearly predict stock price movements in the future in order to minimize these risks (Khaidem et al., 2016).

Weapon-target assignment (WTA) is critical to operational command and directly affects the progression and outcome of operations. WTA is an important military problem studied by numerous military powers. The core concept of WTA is to rapidly and accurately assign weapons to targets and to obtain better solutions to satisfy operational goals (i.e., optimization objectives). These optimization objectives mainly include maximum combat effectiveness, minimum weapon consumption, minimum potential threat of target, minimum target surplus, and minimum incidental damage. According to the number of optimization objectives in the problem, WTA problems can be divided into single-objective WTA (SOWTA) problems, with only one optimization objective, and MOWTA problems, with at least two optimization objectives. Currently, research on the SOWTA problem is more in-depth, and respective

*Corresponding author Email address: babakhajikarimi@abhariau.ac.ir

optimization algorithms can quickly obtain a better allocation scheme. For the SOWTA problem with the background of air defense intercept, Liu et al. proposed a firepower unit correlation matrix and designed a hybrid optimized algorithm based on the PSO and tabu search algorithm. The simulation results show that the method is more efficient than the existing methods and can output optimization results at any time. For the SOWTA problem with the background of against-ground targets, Wang et al. improved the particle initialization and inertia weight selection methods of the PSO algorithm and effectively improved the optimization efficiency and allocation results of the large-scale SOWTA problem. For the dynamic SOWTA problem, Cho et al. constructed a static SOWTA model with several constraints and designed an improved greedy algorithm with phased optimization, which effectively improved the optimization speed of the problem, but it was still solving a static SOWTA problem; Mei et al. constructed a dynamic SOWTA model based on the killing region of weapon platform and proposed a combinatorial algorithm derived from heuristic algorithm and receding horizon control. The experimental results show that the proposed model can describe the combat scene accurately and the algorithm can improve the speed of solving the dynamic SOWTA problem. But there is still a gap from the actual application. Compared with the SOWTA problem, the MOWTA problem considers multiple optimization objectives simultaneously, and the allocation scheme satisfies the multiple operational goals of the decision makers, therein being more in line with the combat and decision makers' needs. Research on the MOWTA problem is lacking, and the optimization speed is slow. This study researches the MOWTA problem and builds a fast optimization algorithm for such problems.

To quickly optimize the MOWTA problem, considering the advantages and disadvantages of the PSO algorithm and multipopulation cooperation strategy, a multipopulation coevolution MOPSO (MPC-MOPSO) algorithm is proposed. The MPC-MOPSO algorithm constructs a master-slave population coevolution model. A slave population corresponds to an objective function for searching noninferior solutions and speeding up the search for noninferior solutions by randomly selecting several noninferior solutions from other populations to replace particles with lower fitness values in the population. The master population receives all the noninferior solutions from the slave populations, repairs the gaps between noninferior solutions, and generates a relatively optimal Pareto optimal solution set. Through the master-slave population coevolution model, the master and slave populations can simultaneously develop different search areas of the problem. This not only maintains the good diversity of the population but also achieves the efficient coordination and global search of multiple populations. Additionally, to accelerate the process by which the populations search for noninferior solutions, repair the gaps between the noninferior solutions, and further improve the global search speed of the MPC-MOPSO algorithm, a multidirectional competition factor is introduced into the particle velocity update to guide the particles to competitively search in multiple directions.

Simulation results show that, compared with the improved MPACO algorithm proposed by Li et al. and the MOPSO-II algorithm proposed by Xia et al. the MPC-MOPSO algorithm has higher computational efficiency and produces better solutions.

In modern and future battlefields, the benefit of assigning smart weapons to targets heavily relies on the assignment of sensors; thus, the sensor-weapon-target assignment (SWTA) problem is derived from the WTA problem. To effectively solve the SWAT problem, Bogdanowicz et al. constructed a model that seeks to rationally assign sensors and weapons to targets for maximum performance. Based on Bogdanowicz et al., Wang et al. modelled the damage probability as the product of the probability of target recognition by a sensor and the damage probability of a weapon paired with the sensor. Xin et al. improved the damage probability model of Wang et al. and modelled the damage probability as the product of the weapon's probability of kill and the sensor's probability of detection. They then proposed a marginal-return-based constructive heuristic (MRBCH) algorithm, which achieved good optimization results. However, the MRBCH algorithm only considers one optimization objective.

Evolutionary algorithms (EA) have been used since the mid-eighties to solve complex single and multi-objective optimisation problems. More recently the Particle Swarm Optimisation (PSO) heuristic, inspired by the flocking and swarm behaviour of birds, insects, and fish schools has been successfully used for single objective optimisation, such as neural network training and non-linear function optimisation. Briefly, PSO maintains a balance between exploration and exploitation in a population (swarm) of solutions by moving each solution (particle) towards both the global best solution located by the swarm so far and towards the best solution that the particular particle has so far located. The global best and personal best solutions are often called guides.

Since, there is an ambiguity in the stock market to determine the real price, the research has been conducted to provide a model that can be used to reduce this ambiguity as much as possible. To provide the model, literature of researches were studied and analyzed. Results of this study show that there were up to 39 variables which were all the variables used in these researches to predict stock prices. The ones that had the highest frequency by obtaining the frequency of each of these variables, are considered as regression model variables as following: price-to-earnings (P/E), number of buyers, inflation rate, exchange rate, oil price, trading volume and total trading index. These variables were considered as independent variables and the share price as a dependent variable in the regression model. Therefore, the researcher tries to answer the question in the research: what is the best way to predict stock price and optimize it by meta-heuristic algorithms?

2. Theoretical Background

Investors are always interested to know the question "how the next trend of stocks will be in the stock market?", because stocks are one of the main decision-making tools in the capital market so it must be determined very

carefully. Therefore, one has to try to identify all those factors as much as possible in order to identify the factors affecting the stock price; then, uses it in the investment decision. Predicting the stock price is not easy due to the lack of clear information on the factors affecting the stock prices and on the presence of complex economic, political, social, and even psychological relationships affecting the stock prices, and most importantly, the inefficiency of the Iranian capital market (Abdolkhani, 2014).

Factors affecting stock prices can be categorized into the following three general categories:

1. Factors related to the company: Factors related to the company are how to manage, the amount of assets and liabilities, decisions on immediate development plans, the cost of capital (opportunity), risk and uncertainty about future profits, and the amount of cash flow of the company.
2. Factors related to the capital market: The second factor of this group is to use mechanized method of stock trading in the stock exchange. In the past, stock trading took several months until the stocks certificate was delivered to the buyer, but the transaction is done in a day now with the mechanized system. Another factor affecting the stock prices in this group is the lack of information. People decide to imitate instead of making scientific calculations and analyzes, when information is not available to everyone enough and there is no transparency of information. The last factor is a return, which people can achieve in other markets. If a part of the country's economic sectors is changed for some reason so that the rate of return on investment in that sector increases, it will cause people in the stock market to sell their resources and engage in high-yield economic activities. Therefore, supplying the stocks increases, resulting in a sharp drop in stock prices, when investors in the stock market are withdrawing their capital from the stock market.
3. Macro factors (Jahankhani, 1997): The third group of factors affecting the stock prices is macroeconomic factors. Companies act in an economic environment that is constantly undergoing economic changes. If the level of change is high, it will affect the stock market value. In this regard, many countries have stabilized the economy before launching the capital market. That is, they provide a calm and predictable environment for the economy so that investors can make decisions and invest by investigating.

2.1. Literature review

Many researches have been done on the subject of research due to the importance of it, some of the most prominent are:

Khan et al. (2020) have been conducted a research entitled "predicting the stock market using machine learning classifiers and social media." They said that investors have interested in predicting the stock market clearly. However, the stock market is driven by unstable factors such as microblogging and news, which make it difficult to predict the stock market index based solely on historical data.

Great fluctuations of stock markets emphasize an effective evaluation of the role of external factors in the stocks prediction to be required. Stock markets can be predicted using machine-learning algorithms for information on social media and financial news, as this data can change investor behavior. They used algorithms in social media and financial news data to discover the effect of this data on the accuracy of predicting the stock market for the next ten days. Features are selected and spam tweets are reduced in the data set to improve the performance and quality of predictions. They used deep learning to achieve maximum predictive accuracy. Their experimental results show that the highest prediction accuracy are achieved using social media and financial news as 80.53% and 75.16%, respectively. They also showed that the New York and Red Hat stock exchanges are difficult to predict. New York and IBM stock exchanges are more influenced by social media, while London and Microsoft stock exchanges are more influenced by financial news. Random forest classification seems to be consistent and the highest accuracy of 83.22% is achieved by their group (Khan et al., 2020).

Abdul Jawad and Kurdy (2019) have been conducted a research entitled "stock market pricing system using neural networks and genomic algorithms." The research uses the following: ten technical indicators as input, genetic algorithm for selecting significant features, nervous system of redemption to predict future stock prices based on the past day's features, and the role of the organization itself to reduce data. The research also compares three integrated predicting models (including SOM-GA-BPN, SOM-BPN, GA-BPN) with one unit (BPN). Three indicators (including NASDAQ, S&P, and IBM) have been suggested to evaluate the performance of mixed methods. The model is compared with other models such as SVR, ANN, RF, SVR-ANN, SVR-RF, SVR-SVR fusion prediction models using evaluation measures. The research results prove the effectiveness comparison and accuracy of suggested indicators and technical methods. In addition, the experimental results show the effectiveness of GA-BPN model compared to other models.

Kerda Varaku (2019) have been conducted a research entitled "predicting the stock price and testing hypothesis using neural networks." In the research, recurrent and multi-layered neural networks are used to predict stock prices from historical data. Data were compared with different test criteria and data normalization techniques. Then, the findings were questioned to test the efficient market hypothesis through a statistical test. This uses DNNs to test the efficient market hypothesis. For this, RNN and MLP were used to predict the movement of stocks in the next quarter using historical stock prices. MLP was divided with random and non-random train and test. In addition, a statistical test was conducted for the null hypothesis where past prices did not affect current prices and in contrast to the other option that they do. The results refuse the null hypothesis so that backward prices are not significant in any estimated models. This encourages the use of better models, different specifications, and different data processing for predicting future stocks movements more clearly.

3. Research Method

The research is an applied research in terms of purpose and is the correlational research. First, the regression model engaged in optimizing the model using the meta-heuristic algorithm. Regression model was used to design the corresponding meta-heuristic algorithm with from MATLAB software. Then, the results were analyzed using EXCEL and MINITAB software.

Population is pharmaceutical companies listed on the stock exchange who have fully reported the relevant information in their financial statements. The research has been conducted in the Iranian Stock Exchange during September 2019 to June 2020.

In this research, all available information and data of Iranian pharmaceutical companies have been used, that is, since we were looking to predict stock prices, it was better to analyze all available data. Therefore, analysis has been conducted on all available data and there were no sampling. Thus, the counting method was conducted.

The growth of pharmaceutical industry was such it supplies 97.5% of domestic drugs consumption. The drug is produced and distributed under government supervision and is a strategic and profitable commodity. Now, 68 pharmaceutical factories produce a variety of pharmaceutical products in the country.

4. Findings

The research has been conducted using the information of Tehran Stock Exchange, of which 50 pharmaceutical companies listed in the Tehran Stock Exchange were considered as population. According to the available information, out of these 50 companies, 11 companies were removed from the selected list due to inadequacy in providing stock pricing data. Finally, the prediction was made for the remaining 25 companies and the stock portfolio was formed with the remaining 25 companies in the stock portfolio.

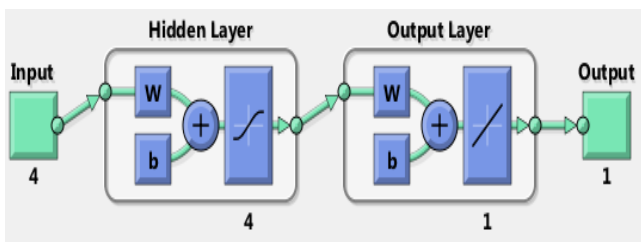

Fig. 1. Multilayer perceptron network with a hidden layer

Table 1
Conditions for stopping the learning process considered in the neural network

Number of iteration	1000
Maximum error reduction	$1e - 8$
Maximum number of times that error reduction failed	6

In this network, the dividerand function was used in MATLAB software as a data separator into three sets of learning, validation, and testing. The data are separated as follows:

- Learning data ratio: 70%
- Validation data ratio: 15%
- Test data ratio: 15%

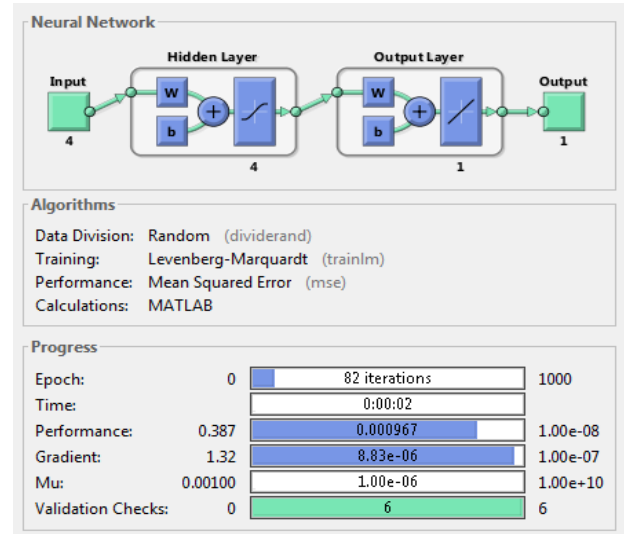

Fig. 2. Neural network learning process

After normalization, the input and output data were placed in the neural network with the mentioned specifications. The algorithm was conducted with 10 iterations in order to ensure the accuracy of the values predicted by the neural network. Finally, the mean and standard deviation of these 10 iterations was obtained. In any iteration of the neural network, values were calculated which show the performance of the neural network in predicting prices. These values included mean square error (MSE), root mean square error (RMSE), regression between actual values with predicted values (R), and regression square (R^2). The results of 10 rows related to these values for 10 iterations of the algorithm are provided for 25 pharmaceutical companies listed in the Tehran Stock Exchange as a mean \pm standard deviation of these 10 iterations, as shown in Table 2.

The results of neural network performance for predicting stocks of 25 pharmaceutical companies are shown in Table 3 in detail. For example, the shares of Alborz Darou Pharmaceutical Company as shown in the first row of Table 1, the mean regression value between the actual and predicted answers for 10 iterations of the algorithm and standard deviation are 0.997 and 0.0007, respectively.

According to the results, stock number 22 has the best neural network performance and stock number 20 has the worst best neural network performance. However, it is suggested by comparing the results that there is not much difference between the neural network results for all stocks; and the difference between the best result and the worst result is very small. All regression values for all stocks are 0.99, which is very close to 1. The closer this value is to 1, the better. The regression square value in the best condition (number 22) and in the worst condition (number 20) is 0.99 and 0.97, respectively.

Table 2
Mean and standard deviation values of the results related to the neural network

Stock	R	R ²	MSE	RSME
1	0.9943 ± 0.0007	0.9887 ± 0.0015	0.0003 ± 0.00005	0.0202 ± 0.0016
2	0.9970 ± 0.0004	0.9959 ± 0.0003	0.0001 ± 0.00003	0.0160 ± 0.0012
3	0.9979 ± 0.0003	0.9971 ± 0.0004	0.0003 ± 0.00001	0.0125 ± 0.0008
4	0.9977 ± 0.0001	0.9970 ± 0.0005	0.0004 ± 0.00003	0.0134 ± 0.0002
5	0.9989 ± 0.0003	0.9979 ± 0.0001	0.0002 ± 0.00001	0.0112 ± 0.0013
6	0.9965 ± 0.0008	0.9925 ± 0.0004	0.0003 ± 0.00002	0.0145 ± 0.0031
7	0.9980 ± 0.0007	0.9978 ± 0.0001	0.0002 ± 0.00002	0.0109 ± 0.0002
8	0.9980 ± 0.0004	0.9973 ± 0.0008	0.0001 ± 0.00008	0.0117 ± 0.0025
9	0.9966 ± 0.0005	0.9955 ± 0.0015	0.0003 ± 0.00006	0.0144 ± 0.0022
10	0.9979 ± 0.0002	0.9975 ± 0.0009	0.0004 ± 0.00005	0.0119 ± 0.0019
11	0.9970 ± 0.0004	0.9956 ± 0.0003	0.0003 ± 0.00002	0.0160 ± 0.0011
12	0.9985 ± 0.0011	0.9976 ± 0.0017	0.00007 ± 0.00001	0.0091 ± 0.0050
13	0.9990 ± 0.0007	0.9988 ± 0.0001	0.00008 ± 0.00004	0.0080 ± 0.0012
14	0.9985 ± 0.0003	0.9982 ± 0.0006	0.00005 ± 0.00006	0.0081 ± 0.0024
15	0.9988 ± 0.0004	0.9979 ± 0.0005	0.0004 ± 0.00002	0.0095 ± 0.0011
16	0.9978 ± 0.0005	0.9969 ± 0.0005	0.0002 ± 0.00004	0.0120 ± 0.0019
17	0.9981 ± 0.0006	0.9958 ± 0.0008	0.0005 ± 0.00001	0.0189 ± 0.0040
18	0.9989 ± 0.0002	0.9981 ± 0.0009	0.00006 ± 0.00006	0.0079 ± 0.0030
19	0.9975 ± 0.0001	0.9970 ± 0.0003	0.0005 ± 0.00002	0.0129 ± 0.0010
20	0.9972 ± 0.0029	0.9740 ± 0.0060	0.0019 ± 0.0007	0.0429 ± 0.0059
21	0.9991 ± 0.00009	0.9979 ± 0.0001	0.0001 ± 0.00003	0.0102 ± 0.0003
22	0.9994 ± 0.0003	0.9980 ± 0.0006	0.00007 ± 0.000002	0.0090 ± 0.0001
23	0.9984 ± 0.0004	0.9965 ± 0.0002	0.0002 ± 0.00001	0.0150 ± 0.0008
24	0.9981 ± 0.0007	0.9971 ± 0.0012	0.0004 ± 0.00009	0.0140 ± 0.0025
25	0.9978 ± 0.0004	0.9970 ± 0.0004	0.0005 ± 0.00004	0.0135 ± 0.0013

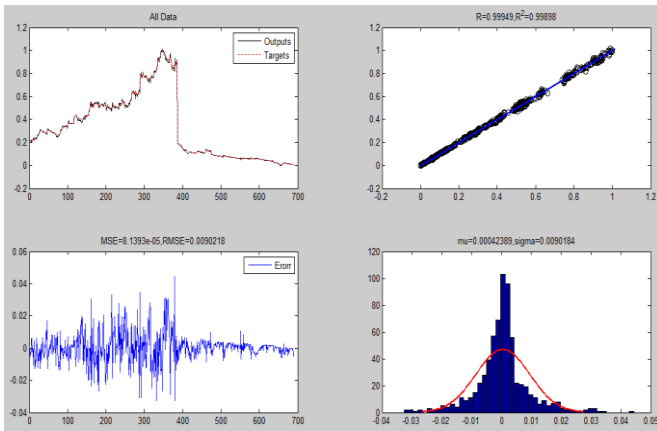

Fig. 3. Neural network output diagrams for Dr. Abidi Pharmaceutical Company as the best ranking

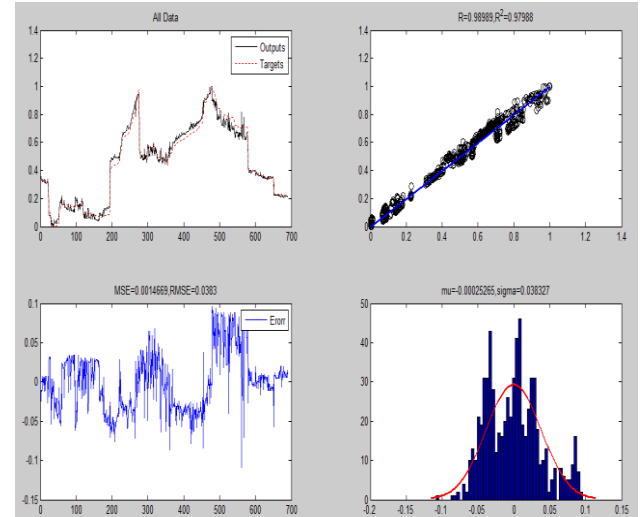

Fig. 5. Neural network output diagrams for Razak Pharmaceutical Company as the worst ranking.

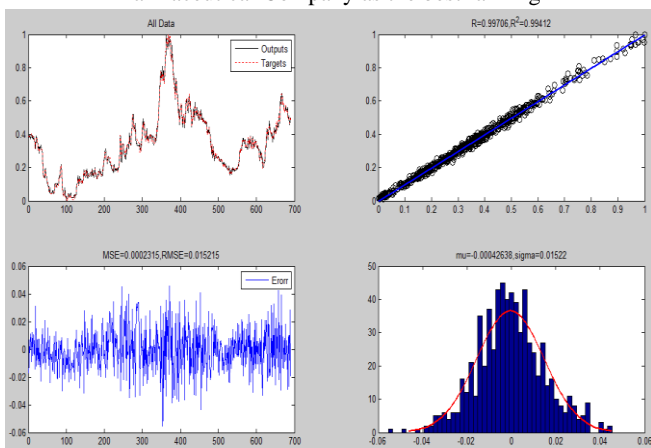

Fig. 4. Neural network output diagrams for Farabi Pharmaceutical Company as the middle ranking

As shown in the illustrated charts for the best to worst ranking, the price prediction charts (black curve) are very much in line with the red curve, which indicates the best performance for predicting the stock prices in pharmaceutical companies. The smaller the difference between the two curves, the closer the regression value (line slope) is to 1, which indicates that the predicted value is close to the actual value. This also illustrated on the top right of the chart because the predicted values are very close to the performance line (blue curve). Therefore, results indicate the proper performance of neural network to predict the stock prices in pharmaceutical companies.

According to the good results obtained from the first phase, we should use the predicted values as input data for the second phase in order to optimize the stock portfolio of pharmaceutical companies.

In the first phase of the research, we predicted the stock prices in pharmaceutical companies with multilayer perceptron neural network. Using the values predicted in the previous phase, we optimize the portfolio now using a multi-objective meta-heuristic algorithm. In this regard, we use the multi-objective particle swarm optimization (MOPSO) algorithm, which is widely used in answering multi-objective problems. The current algorithm studies the stocks of 25 pharmaceutical companies in the stocks portfolio in terms of both risk and return objectives. These portfolios include all or some of these stocks with a certain ratio that shows the impact of each stock in the portfolio. The number of stocks in the portfolio is proportional to the population considered in the algorithm, which is formed our Pareto-front. The Pareto-front suggests the best answer, which is the best stock among 25 stocks of pharmaceutical companies.

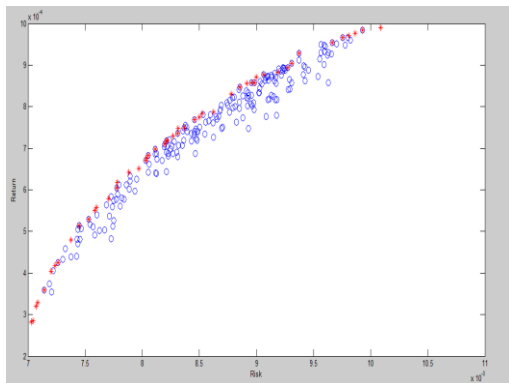

Fig. 6. Illustration of the efficient boundary of running MOPSO algorithm with the effect of variance risk criterion without stock market value

In addition, the efficiency boundary of running MOPSO algorithm with the effect of different risk criteria under the market value criterion is illustrated in figure 7.

After illustrating the efficiency boundary of running MOPSO algorithm under both considering market value and not

Table 3
Optimal answer in 10 times running MOPSO algorithm

	1	2	3	4	5	6	7	8	9	10	s.d
Mv	0.0069	0.0075	0.0084	0.0072	0.0082	0.0081	0.0089	0.0073	0.0074	0.0069	0.0004
Msv	0.0074	0.0073	0.0071	0.0078	0.0083	0.0065	0.0075	0.0091	0.0079	0.0067	0.0005
Mad	0.0055	0.0064	0.0049	0.0077	0.0051	0.0051	0.0047	0.0054	0.0044	0.0046	0.0003
cvar	0.0186	0.0173	0.0179	0.0153	0.0180	0.0149	0.0165	0.0177	0.0143	0.0157	0.0013

Table 4
Comparison of stock portfolio efficiency with market value and without market value under different risk criteria

Risk criterion	mv			msv			mad			cvar		
Method	Risk	Returns	Efficiency	Risk	Returns	Efficiency	Risk	Returns	Efficiency	Risk	Returns	Efficiency
With market value	0.0084 8	0.0006 4	0.0690	0.0084 0	0.0007 8	0.0890	0.0061 5	0.0005 8	0.0900	0.016 2	0.0007 0	0.0401
Without market value	0.0083 2	0.0005 7	0.0561	0.0078 2	0.0005 3	0.0655	0.0066 2	0.0006 0	0.0825	0.017 0	0.0006 2	0.0348

considering market value conditions, it is time to study the stability of MOPSO algorithm. Stability condition is the convergence of producing the same answers in 10 consecutive iterations. In order for the convergence stability condition to be met, the MOPSO algorithm is run 10 times in four different models, the results of which are shown in Table 4 and figures. The data shown in table 4 indicate the maximum stock value of 25 pharmaceutical companies listed in the Tehran Stock Exchange.

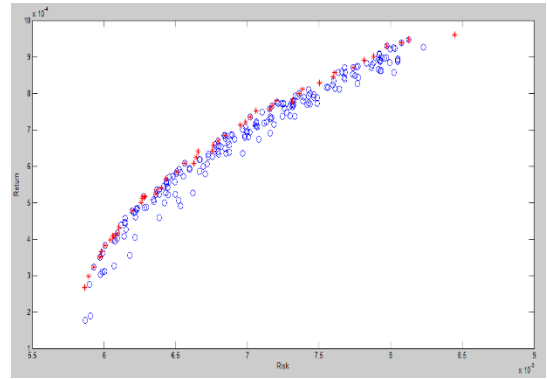

Fig. 7. Illustration of the efficient boundary of running MOPSO algorithm with the effect of variance risk criterion under stock market value

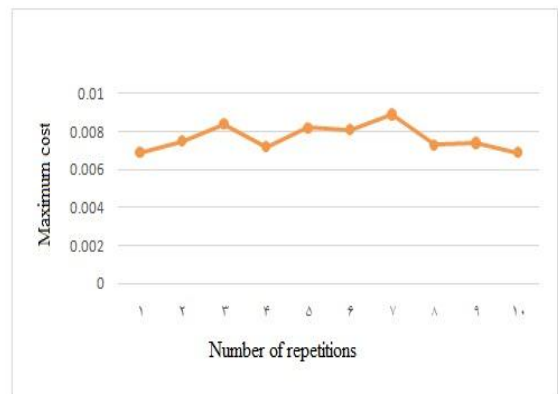

Fig. 8. Optimal answer of MOPSO algorithm under variance risk

To show clearly which risk criterion has the best performance when we use the future and predicted stock prices to create and optimize a stock portfolio, we compare the efficiency of portfolios created by four models under different risk criteria using future stock prices. The results of return, risk, and efficiency of stock portfolios created under these 4 models with different risk criteria are shown in Table 5.

In order to evaluate the accuracy of the perceptron neural network algorithm with the back propagation of error algorithm in the optimization process of stock portfolio, we conduct the optimization process once using the neural network and once not using this network and using the past stock data. The mean of returns, risk, and efficiency of

stock portfolios created by both methods and for all four models is shown in Table 6. In the table, the mentioned values are compared for both methods

Table 5
Comparison of stock portfolio efficiency under different risk criteria

Risk criterion	stock portfolio risk	Stock portfolio returns	Stock portfolio efficiency
Mv	0.00848	0.00064	0.0690
Msv	0.00840	0.00078	0.0885
Mad	0.00615	0.00058	0.0900
Cvar	0.0162	0.00070	0.0401

Table 6
Investigation of neural network effect coefficient in the final answer

Risk criterion	mv			msv			mad			cvar		
	Method	Risk	Returns	Efficiency	Risk	Returns	Efficiency	Risk	Returns	Efficiency	Risk	Returns
Using neural network	0.00848	0.00064	0.0690	0.00840	0.00078	0.0885	0.00615	0.00062	0.0900	0.0162	0.00070	0.0400
Not using neural network	0.00692	0.00038	0.0548	0.00680	0.00050	0.0692	0.00437	0.00038	0.0871	0.0132	0.00070	0.0490

5. Conclusion

Optimizing the stock of listed companies was conducted using multi-objective MOPSO algorithm under four different risk criteria. Determining efficient boundary, which includes the number of optimal stock portfolios, was calculated in terms of both risk and return criteria. For predicting the stocks of pharmaceutical companies, market value was used as an important variable for investing in the stock exchange and stock market. The effect of this variable on optimizing the stocks of pharmaceutical companies was tested by comparing the efficiency boundary for both using market value variable and not using market value variable conditions. It showed that market value variable affect in predicting the stocks of pharmaceutical companies. The mean regression value and standard deviation between answers of actual and predicted price for 10 iterations of the algorithm is 0.997 and 0.0007, respectively. The high value of regression and its value close to one show a well performance of the neural network for predicting price values. In addition, the standard deviation between 10 iterations is very small, which shows the stability of neural network algorithm for the relevant prediction. The regression square value that is a more accurate and reliable value than regression, is 0.98, of which a high value and a value close to one indicates the good performance of the neural network. For this parameter, standard deviation is 0.0015 and is very small, which indicated the good performance of the neural network for predicting. The mean square error and the root mean square error for these stocks indicate a very small error of neural network for predicting the stocks of pharmaceutical companies. These values are very small and close to zero. Findings are in line with Arvy (2015), Pew et al. (2017), Quan Jin et al. (2017), Zhong Bao Zhou et al. (2018), Kamalov (2019), Abdul Javad and Kurdy

(2019), Bayat and Bagheri (2016), Faghiehinejad and Minaei (2017), Naghdi and Arab Mazar Yazdi (2017), Dolou and Heidari (2017), Khanbeigi and Abdolvand (2017), Gholamian and Davoodi (1397) researches.

References

Alirezaie, A., Hajmohammad, M. H., Ahangar, M. R. H., & Esfe, M. H. (2018). Price-performance evaluation of thermal conductivity enhancement of nanofluids with different particle sizes. *Applied Thermal Engineering*, 128, 373-380.

Al-Waeli, A. H., Sopian, K., Kazem, H. A., Yousif, J. H., Chaichan, M. T., Ibrahim, A., ... & Ruslan, M. H. (2018). Comparison of prediction methods of PV/T nanofluid and nano-PCM system using a measured dataset and artificial neural network. *Solar Energy*, 162, 378-396.

Amiri, M. (2007). Optimizing the stock portfolio using counter-ideal compromise planning. *Industrial Management Studies*, 6 (15), 143-165.

Behnamian, J. (2016). Multi-objective scheduling of multi-factory production networks using subpopulation genetic algorithm and elastic method. *Journal of Industrial Engineering Research in Production Systems*, 3 (6), 133-147.

Bermúdez, J. D., Segura, J. V., & Vercher, E. (2012). A multi-objective genetic algorithm for cardinality constrained fuzzy portfolio selection. *Fuzzy Sets and Systems*, 188(1), 16-26.

Bhattacharyya, R., Hossain, S. A., & Kar, S. (2018). Fuzzy cross-entropy, mean, variance, skewness models for portfolio selection. *Journal of King Saud University-Computer and Information Sciences*, 26(1), 79-87.

Bogdanowicz, Z and Coleman, N. (2007). Sensor-target and weapon-target pairings based on auction algorithm, in Proceedings of the 11th WSEAS

- International Conference on Applied Mathematics, pp. 92–96, .
- Chatsanga, N., & Parkes, A. J. (2017). Two-Stage Stochastic International Portfolio Optimisation under Regular-Vine-Copula-Based Scenarios. arXiv preprint arXiv:1704.01174.
- Chen, M. Y., & Chen, B. T. (2015). A hybrid fuzzy time series model based on granular computing for stock price forecasting. *Information Sciences*, 294, 227-241.
- Cho, D.H. and H.-L. Choi, “Greedy maximization for asset-based weapon-target assignment with time-dependent rewards,” *Cooperative Control of Multi-Agent Systems: Theory and Applications*, pp. 115–139, 2017.
- Dash, R. (2018). Performance analysis of a higher order neural network with an improved shuffled frog leaping algorithm for currency exchange rate prediction. *Applied Soft Computing*, 67, 215-231.
- Di Persio, L., & Honchar, O. (2016). Artificial neural networks architectures for stock price prediction: Comparisons and applications. *International journal of circuits, systems and signal processing*, 10(2016), 403-413.
- Ekonomou, L. (2010). Greek long-term energy consumption prediction using *artificial neural networks*. *Energy*, 35(2), 512-517.
- Esfef, M. H., Rostamian, H., Esfandeh, S., & Afrand, M. (2018). Modeling and prediction of rheological behavior of Al₂O₃-MWCNT/5W50 hybrid nanolubricant by artificial neural network using experimental data. *Physica A: Statistical Mechanics and its Applications*, 510, 625-634.
- Ghanbari, R., Yazdani, Z., & Sofli, S. (2016). Providing an algorithm for fuzzy planning problem of optimal selection of multi-period capital portfolio in an uncertainty space. 3rd National Conference on Mathematical Modeling in Operations Research.
- Ghorbani, N., Babaei, E., & Sadikoglu, F. (2017). Exchange market algorithm for multi-objective economic emission dispatch and reliability. *Procedia computer science*, 120, 633-640.
- Granger, C. W. (1992). Forecasting stock market prices: Lessons for forecasters. *International Journal of Forecasting*, 8(1), 3-13.
- Guangyuan Fu, Chao Wang, Daqiao Zhang, Jiufen Zhao, Hongqiao Wang, “A Multiobjective Particle Swarm Optimization Algorithm Based on Multipopulation Coevolution for Weapon-Target Assignment,” *Mathematical problem in engineering* volume 2019, article ID 1424590, 11 page, <https://doi.org/10.1155/2019/1424590>.
- Hamid, S. A., & Habib, A. (2014). Financial forecasting with neural networks. *Academy of Accounting and Financial Studies Journal*, 18(4), 37.
- Hiller, R. S., & Eckstein, J. (1993). Stochastic dedication: Designing fixed income portfolios using massively parallel Benders decomposition. *Management Science*, 39(11), 1422-1438.
- Kennedy, J., Eberhart, R.: Particle Swarm Optimization. In: Proceedings of the Fourth IEEE International Conference on Neural Networks, pp. 1942–1948 (1995).
- Kiani, M. (2016). Optimizing the stock portfolio based on the minimum level of total risk acceptance and its components using genetic algorithm method.
- Kianian, M., Pendict, R., and Robinfield, D. (1991). *Econometric patterns and economic predictions*, Tehran: Organization for Researching and Composing University Textbooks in the Humanities.
- Köksalan, M., & Şakar, C. T. (2016). An interactive approach to stochastic programming-based portfolio optimization. *Annals of Operations Research*, 245(1-2), 47-66.
- Kouwenberg, R. (2001). Scenario generation and stochastic programming models for asset liability management. *European Journal of Operational Research*, 134(2), 279-292.
- Li, X., Wang, S. S., & Wang, X. (2017). Trust and stock price crash risk: Evidence from China. *Journal of Banking & Finance*, 76, 74-91.
- Li, X., Xie, H., Wang, R., Cai, Y., Cao, J., Wang, F., ... & Deng, X. (2016). Empirical analysis: stock market prediction via extreme learning machine. *Neural Computing and Applications*, 27(1), 67-78.
- Li, X., Yang, L., Xue, F., & Zhou, H. (2017, May). Time series prediction of stock price using deep belief networks with intrinsic plasticity. In 2017 29th Chinese Control And Decision Conference (CCDC) (pp. 1237-1242). IEEE.
- Li, Y. Kou, Z. Li et al., “A modified pareto ant colony optimization approach to solve biojective weapon-target assignment problem,” *International Journal of Aerospace Engineering*, vol. 2017, Article ID 1746124, 14 pages, 2017.
- Liu, Z. Shi, L. Wu et al., “Solving cooperative anti-missile weapon-target assignment problems using hybrid algorithms based on particle swarm and tabu search,” *International Conference on Computer Science and Application Engineering*, pp. 898–906, 2017.
- Management, studies, and economic studies of the Stock Exchange Organization. (1997). *The position of the Tehran Stock Exchange in comparison with other stock exchanges in the world*. Tehran: Tehran Stock Exchange Organization.
- Mankiw, N. G., Romer, D., & Shapiro, M. D. (1991). Stock market forecastability and volatility: a statistical appraisal. *The Review of Economic Studies*, 58(3), 455-477.
- Mansini, R., Ogryczak, W., & Speranza, M. G. (2007). Conditional value at risk and related linear programming models for portfolio optimization. *Annals of operations research*, 152(1), 227-256.
- Mei, Z. Peng, and X. Zhang, “Optimal dynamic weapon-target assignment based on receding horizon control heuristic,” in *Proceedings of the 13th IEEE International Conference on Control and Automation, ICCA 2017*, pp. 876–881, Macedonia, Balkans, July 2017.
- Messaoudi, L., & Rebai, A. (2013, April). A fuzzy stochastic Goal Programming approach for solving portfolio selection problem. In *Modeling, Simulation*

- and Applied Optimization (ICMSAO), 2013 5th International Conference on (pp. 1-5). IEEE.
- Mishra, S. K., Panda, G., Majhi, B., & Majhi, R. (2012, July). Improved portfolio optimization combining multiobjective evolutionary computing algorithm and prediction strategy. In *World Congress on Engineering* (Vol. 1).
- Montgomery, D. C., Johnson, L. A., & Gardiner, J. S. (1990). *Forecasting and time series analysis*. McGraw-Hill Companies.
- Namazi, M., and Shoushtarian, Z. (1996). A review of stock exchange performance tests at a low level. *Journal of Financial Research*, No. 11 and 12, pp. 62-109.
- Pagnoncelli, B. K., Reich, D., & Campi, M. C. (2012). Risk-return trade-off with the scenario approach in practice: a case study in portfolio selection. *Journal of Optimization Theory and Applications*, 155(2), 707-722.
- Park, S. K., Moon, H. J., Min, K. C., Hwang, C., & Kim, S. (2018). Application of a multiple linear regression and an artificial neural network model for the heating performance analysis and hourly prediction of a large-scale ground source heat pump system. *Energy and Buildings*, 165, 206-215.
- Rajabzadeh Qatarami, A. (1998). Mixed evaluation of predicting methods and providing an optimal model for predicting the stock price in the Tehran Stock Exchange. Master Thesis, Tarbiat Modares.
- Rezaee, M. J., Jozmaleki, M., & Valipour, M. (2018). Integrating dynamic fuzzy C-means, data envelopment analysis and artificial neural network to online prediction performance of companies in stock exchange. *Physica A: Statistical Mechanics and its Applications*, 489, 78-93.
- Shunhong, Q. Yang, R. Wang et al., "Particle Swarm Optimization based weapon-target assignment for attacking ground targets," *Electronics Optics & Control*, vol. 24, no. 3, pp. 36-40, 2017.
- Sureshkumar, K. K., & Elango, N. M. (2012). Performance analysis of stock price prediction using artificial neural network. *Global journal of computer science and Technology*.
- Ticknor, J. L. (2013). A Bayesian regularized artificial neural network for stock market forecasting. *Expert Systems with Applications*, 40(14), 5501-5506.
- Vega Ezpeleta, E. (2016). Modeling volatility for the Swedish stock market.
- Wang, J. and. Chen, C.(215).Sensor-weapon joint management based on improved genetic algorithm," in *Proceedings of the 34th Chinese Control Conference*, pp. 2738-2742.
- Wei, L. Y. (2016). A hybrid ANFIS model based on empirical mode decomposition for stock time series forecasting. *Applied Soft Computing*, 42, 368-376.
- Xin, B., Wang, Y. & J. Chen, (2018).An efficient marginal-return-based constructive heuristic to solve the sensor-weapon-target assignment problem," *IEEE Transactions on Systems, Man, and Cybernetics: Systems*, pp. 1-12.
- Xinxue, X., Yangtao, L. & Fan et al., (2016). Weapon-target assignment with an improved multi-objective particle swarm optimization algorithm," *Acta Armamentarii*, vol. 37, no. 11, pp. 2085-2093, 2016.
- Yang, X. S. (2010). *Nature-inspired metaheuristic algorithms*. Luniver press.
- Zhang, W. G., Liu, Y. J., & Xu, W. J. (2017). A possibilistic mean-semivariance-entropy model for multi-period portfolio selection with transaction costs. *European Journal of Operational Research*, 222(2), 341-349.

Khazaei, A., Haji Karimi, B., Mozaffari, M. (2021). Optimizing The Stock Price Forecasting Model Of Pharmaceutical Companies Using Aggregate Particle Swarm Algorithm (MOPSO). *Journal of Optimization in Industrial Engineering*, 14(2), 89-97.

http://www.qjie.ir/article_677889.html
DOI:10.22094/JOIE.2020.677889

